

Article number: 3918049060223

Description: Worm gear with st. steel hollow shaft  
VF 49 EP-A-60- 63B14

## Measures

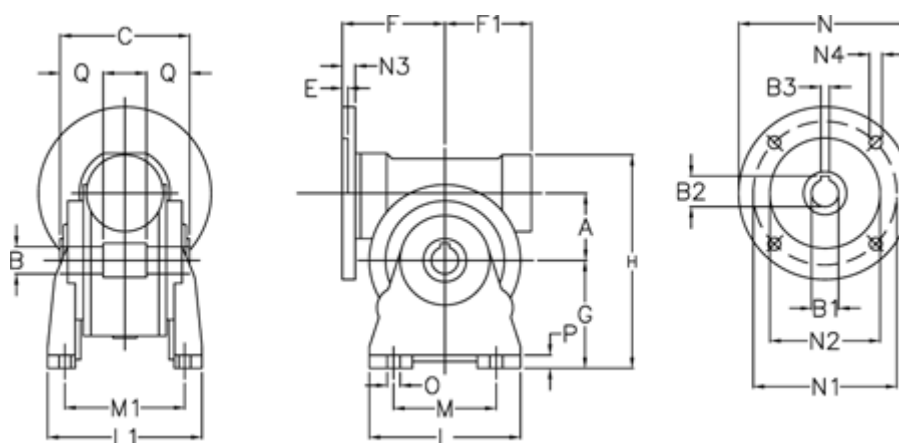

a = 49.5	F1 = 63	N1 = 75
B = 25	g = 82	N2 = 60
B1 E7 = 11	H = 162	N3 = 7.0
B2 = 12.8	L = 110	N4 = 6.0
B3 H9 = 4	L1 = 124.0	O = 8.5
C = 82	m = 63	P = 12
E = 3.0	M1 = 98.5	Q = 22.5
F = 70	N = 90	